

Publish Date : 18.03.2019 | Rev no: 01

PowerMAX Cat.6 UTP Solid RJ45 Plug - 2 Piece

Applications

- 10 Base-T (IEEE 802.3)
- Fast Ethernet (IEEE 802.3u)
- 100Vg-AnyLAN (IEEE 802-12)
- Token Ring (IEEE 802.5)
- TP-PMD (ANSI X 3T9.5)
- 100 Mbps CDDI
- ATM 155
- Gigabit 1000 Mbps (802.3z)

Standards

- ETL Verified
- ANSI/TIA-568-2.D
- ISO/IEC 11801
- EN 50173

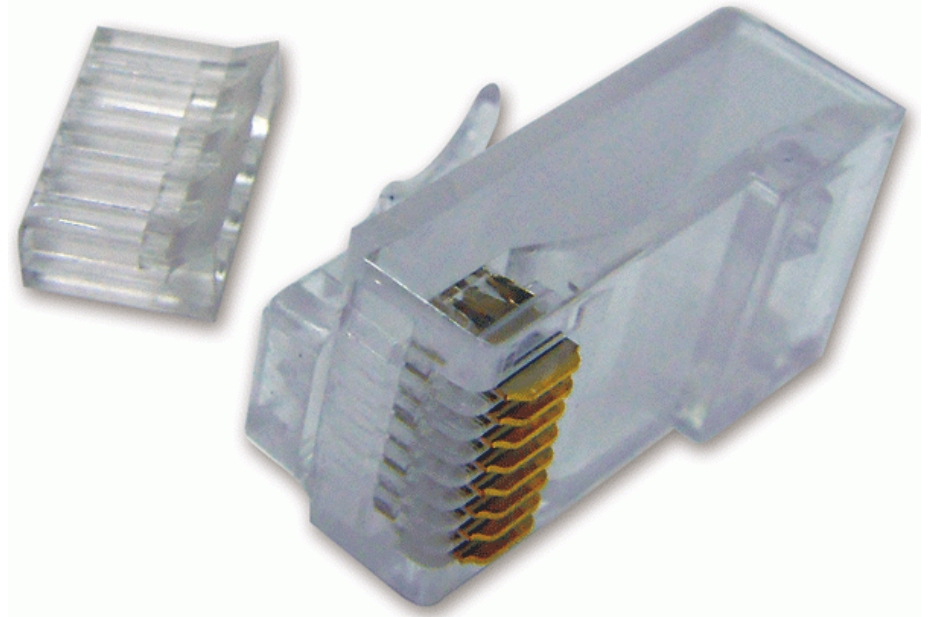

Electrical Characteristics

- Dielectric with standing voltage: 1000VAC (RMS)
- Contact resistance: 10 milliOhms max.
- Current rating: 30 VAC at 1.5 AMPS
- Insulation resistance: 500 Megaohms min.

Mechanical

- Cable-to-Plug tensile Round & flat cable available
- Strength: 20 lbs. min.
- Durability: 750 cycles min.
- Operating temperature : -20°C to +75°C

RJ-45 shielded Plug
3 prong type

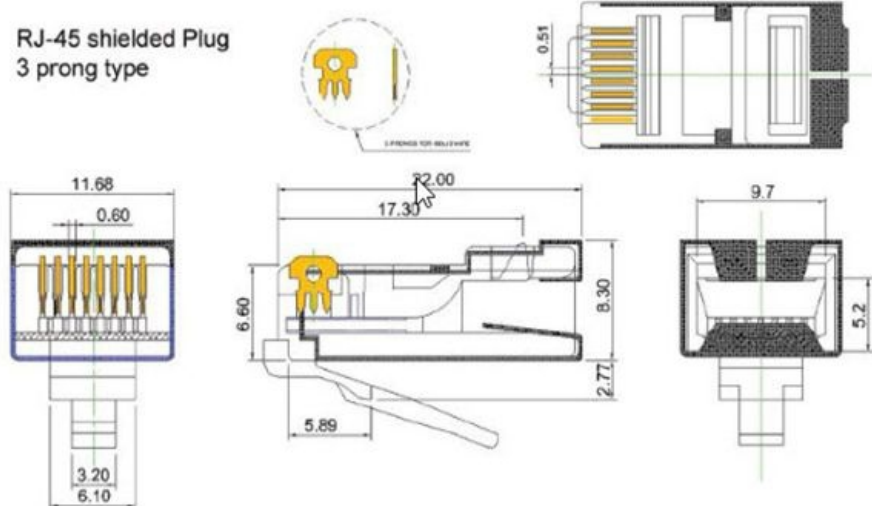

Material and Finish

- Housing: Poly-carbonate
- Contact material: Phosphor bronze alloy
- Contact: Copper alloy 50u" gold over nickel

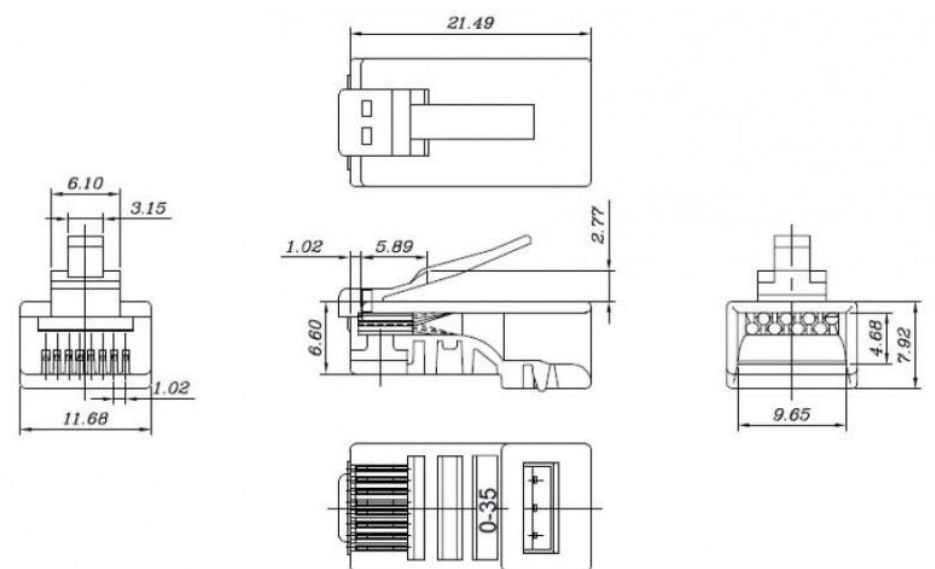

Ordering Information

Product Number	Product Name	Category	Std Pkg Qty	Std Ctn Qty
1501-88028	Cat.6 RJ45 plug for unshielded solid wire 23-26AWG - 2 piece / with load bar	Cat.6	1200pcs/box	7200pcs/carton
1501-88027	Cat.6 RJ45 plug for unshielded solid wire 23-26AWG - 1 piece	Cat.6	1200pcs/box	7200pcs/carton